

Coaxial Two Way Plug-in Switch (DPDT) | BN 553364



Typical illustration

Radio frequency characteristics

Interface type (4 connections)	29.5-68 USL-D according to company standard 61774		
Characteristic impedance	50 Ω		
Frequency range	0 to 100 MHz	100 to 230 MHz	230 to 860 MHz
VSWR, max.	1.04	1.04	1.04
Isolation, min.	80 dB	80 dB	70 dB
Insertion loss, max.	0.1 dB	0.1 dB	0.1 dB
Average power capability ^{RFC1)} at ambient temperature -10 to +45°C	41 kW	27 kW	14 kW
Peak voltage capability ^{RFC1)}	8.1 kV		

RFC1) Standard conditions: - Dielectric: Dry air under standard pressure at sea level ($p = 1013 \text{ hPa}$)
 - Load VSWR, max. 1.0 (no standing wave)
 - No modulation, sinusoidal carrier only

Electrical and mechanical characteristics

Switch type	Two way switch, DPDT	
Actuator type	Motor drive, latching, self cutoff	
Locking plug for USL-Interlock I	Connector J3 ^{EMC1)}	8 pole SPINNER connector BN 125651
	Maximum ratings	ES1 circuits according to EN 62368-1, 42.4 V ACpk / 60 V DC / 0.5 A
	Current limiting	The circuits must be limited externally to 0.5 A
Connector J2 ^{EMC2)} for mains connection	5 pole SPINNER connector BN 126920, certified according to VDE-Reg. No. B687, DIN EN 61984: 2009-11; EN 61984: 2009	
Mains connection	L, N, PE, TN-System	
Operating	Operating voltage	187 to 253 V AC 50/60 Hz
	Operating current, typ. ^{EMC3)}	1 A
	Nominal fuse	The switch must be secured externally by a time-delay fuse, 2 A
Connector J1 ^{EMC2)} for control, interlock contacts and signaling	25 pole connector according to DIN 41652 / IEC 807-2	
Control	Control voltage	ES1 circuits according to EN 62368-1, 8 to 31 V DC
	Control current, typ.	12 mA at control voltage 24 V DC
	Current limiting	The circuit must be limited externally to 0.5 A



Coaxial Two Way Plug-in Switch (DPDT) | BN 553364

Signal contacts Interlock contacts	Maximum ratings	ES1 circuits according to EN 62368-1, 42.4 V ACpk / 60 V DC / 0.5 A
	Current limiting	The circuit must be limited externally to 0.5 A
Switching time, typ. ^{EMC3)}		0.2 s
Command hold time, min.		0.2 s (during this time, the voltage at control input must not change)
Switching frequency, max.		10 operations per minute
Life, min.		250,000 operations
Weight, approx.		9 kg

EMC1) Suitable SPINNER mating connector BN 539145 not part of delivery!

EMC2) Suitable mating connector included

EMC3) At room temperature and nominal voltage 230 V AC

Environmental conditions

Operational conditions	ETSI EN 300 019-1-3 V2.3.2 (2009-1) class 3.1 N
Ambient temperature ^{EC1)}	-10 to +60°C
Condensation	Not allowed
Relative humidity, max.	95%

The maximum input power can be applied up to 500 m or 1600 ft above sea level unless noted otherwise in the data sheet. Above this height the maximum input power must be reduced as shown in the diagram.

Derating of input power with increasing altitude

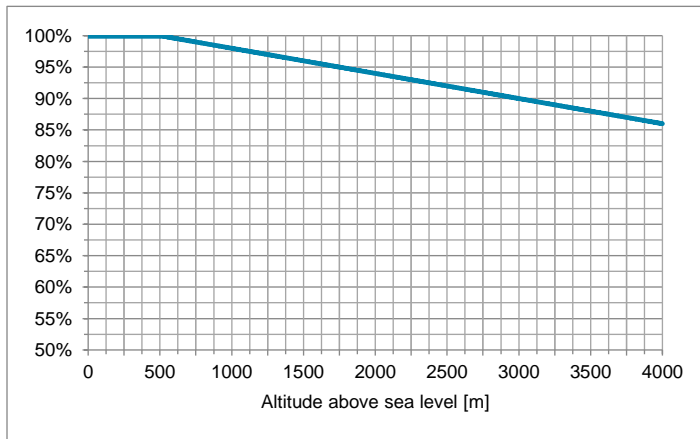

The maximum voltage can be applied up to 500 m or 1600 ft above sea level unless noted otherwise in the data sheet. Above this height the voltage must be reduced as shown in the diagram.

Derating of voltage with increasing altitude

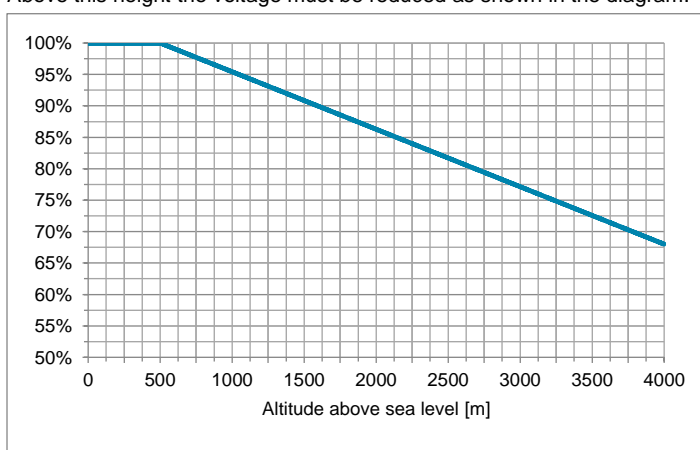

SPINNER GmbH
 This document is proprietary to us.
 All rights reserved. Any use, transfer, or reproduction of this document
 or the know-how contained therein requires our express consent.

Template 10014442.docx



Coaxial Two Way Plug-in Switch (DPDT) | BN 553364

<p>Derating of input power with increasing ambient temperature</p>	<p>The maximum input power can be applied up to +45°C ambient temperature unless noted otherwise in the data sheet. Above this ambient temperature the maximum input power must be reduced as shown in the diagram.</p> <table border="1"> <caption>Derating of input power with increasing ambient temperature</caption> <thead> <tr> <th>Ambient temperature [°C]</th> <th>Input Power (%)</th> </tr> </thead> <tbody> <tr><td>-10</td><td>100</td></tr> <tr><td>0</td><td>100</td></tr> <tr><td>10</td><td>100</td></tr> <tr><td>20</td><td>100</td></tr> <tr><td>30</td><td>100</td></tr> <tr><td>40</td><td>100</td></tr> <tr><td>45</td><td>100</td></tr> <tr><td>50</td><td>95</td></tr> <tr><td>55</td><td>90</td></tr> <tr><td>60</td><td>83</td></tr> </tbody> </table>	Ambient temperature [°C]	Input Power (%)	-10	100	0	100	10	100	20	100	30	100	40	100	45	100	50	95	55	90	60	83
Ambient temperature [°C]	Input Power (%)																						
-10	100																						
0	100																						
10	100																						
20	100																						
30	100																						
40	100																						
45	100																						
50	95																						
55	90																						
60	83																						
<p>Max. altitude above sea level</p>	<p>4,000 m or 13,120 ft according to IEC EN 60664-1</p>																						
<p>Protection class</p>	<p>I according to IEC EN 61140</p>																						
<p>IP protection level</p>	<p>IP40 according to IEC EN 60529 (all interfaces terminated)</p>																						
<p>Installation position</p>	<p>Any</p>																						
<p>Transport conditions</p>	<p>ETSI EN 300 019-1-2 V2.1.4 (2003-04) class 2.2</p>																						
<p>Ambient temperature</p>	<p>-25 to +70°C</p>																						
<p>Rain, condensation, icing</p>	<p>Not allowed</p>																						
<p>Storage conditions</p>	<p>ETSI EN 300 019-1-1 V2.1.4 (2003-04) class 1.2</p>																						
<p>Ambient temperature</p>	<p>-10 to +60°C</p>																						
<p>Rain, condensation, icing</p>	<p>Not allowed</p>																						

EC1) Extended temperature range on request

Applicable documents

<p>Product manual</p>	<p>M36274</p>
-----------------------	---------------

SPINNER GmbH
 This document is proprietary to us.
 All rights reserved. Any use, transfer, or reproduction of this document
 or the know-how contained therein requires our express consent.

Template 10014442.dotx

Coaxial Two Way Plug-in Switch (DPDT) | BN 553364

Power handling vs. frequency

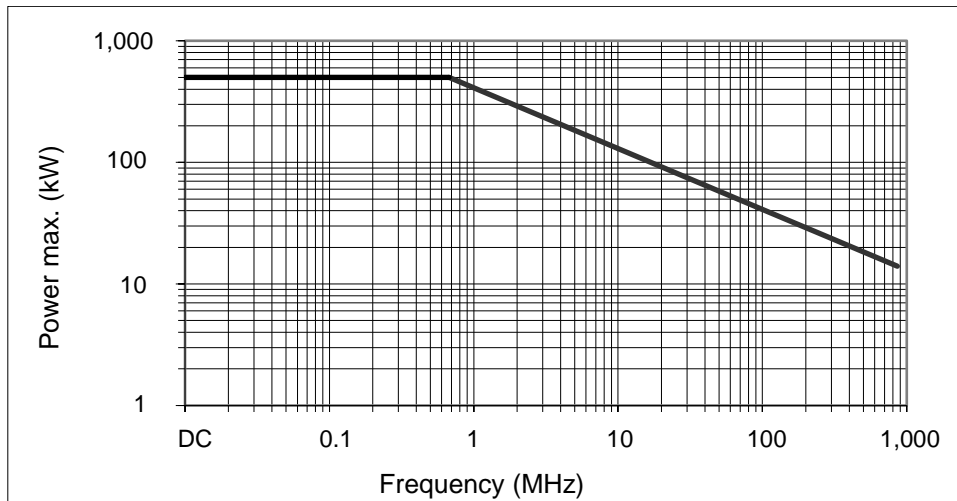

Typical diagram

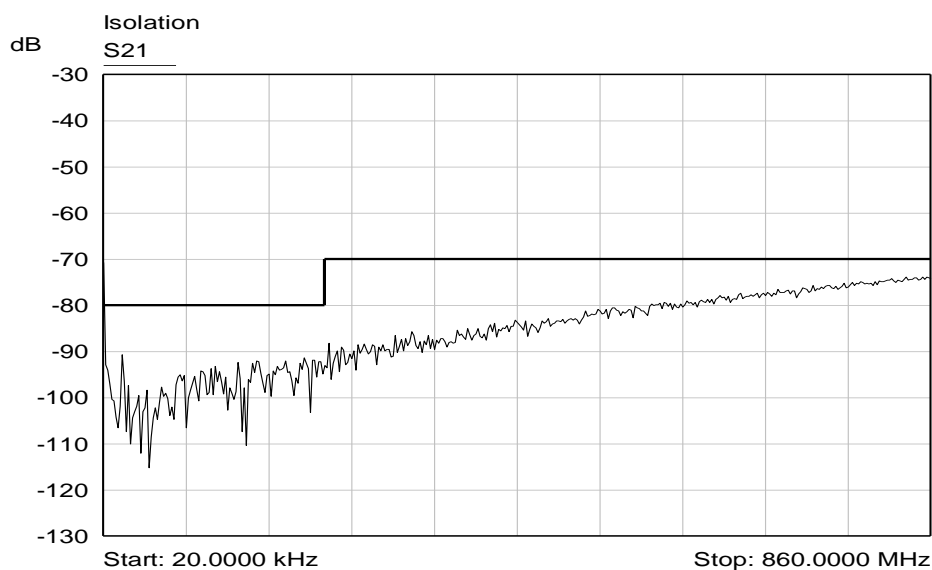
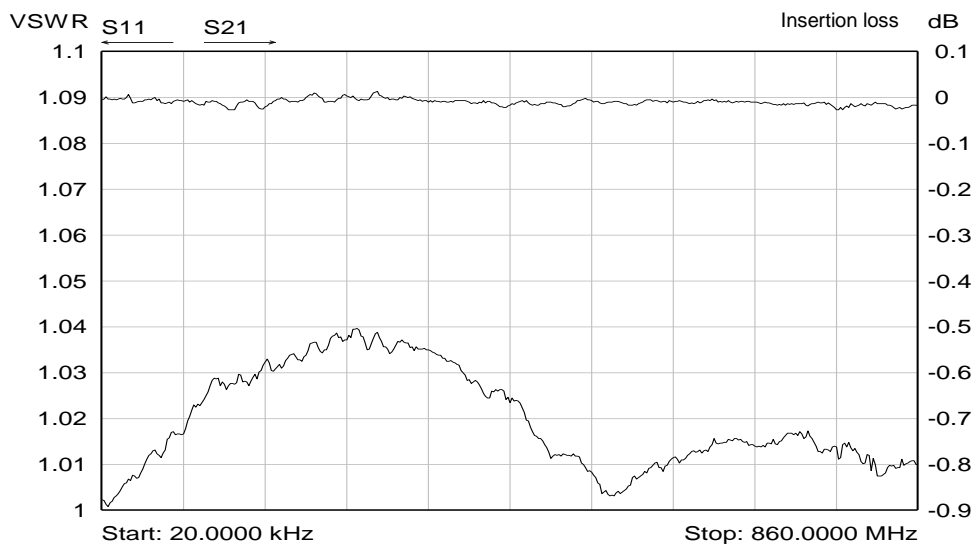

SPINNER GmbH
 This document is proprietary to us.
 All rights reserved. Any use, transfer, or reproduction of this document
 or the know-how contained therein requires our express consent.

Template 10014442.dotx

Coaxial Two Way Plug-in Switch (DPDT) | BN 553364

Outline (all dimensions in millimeter)

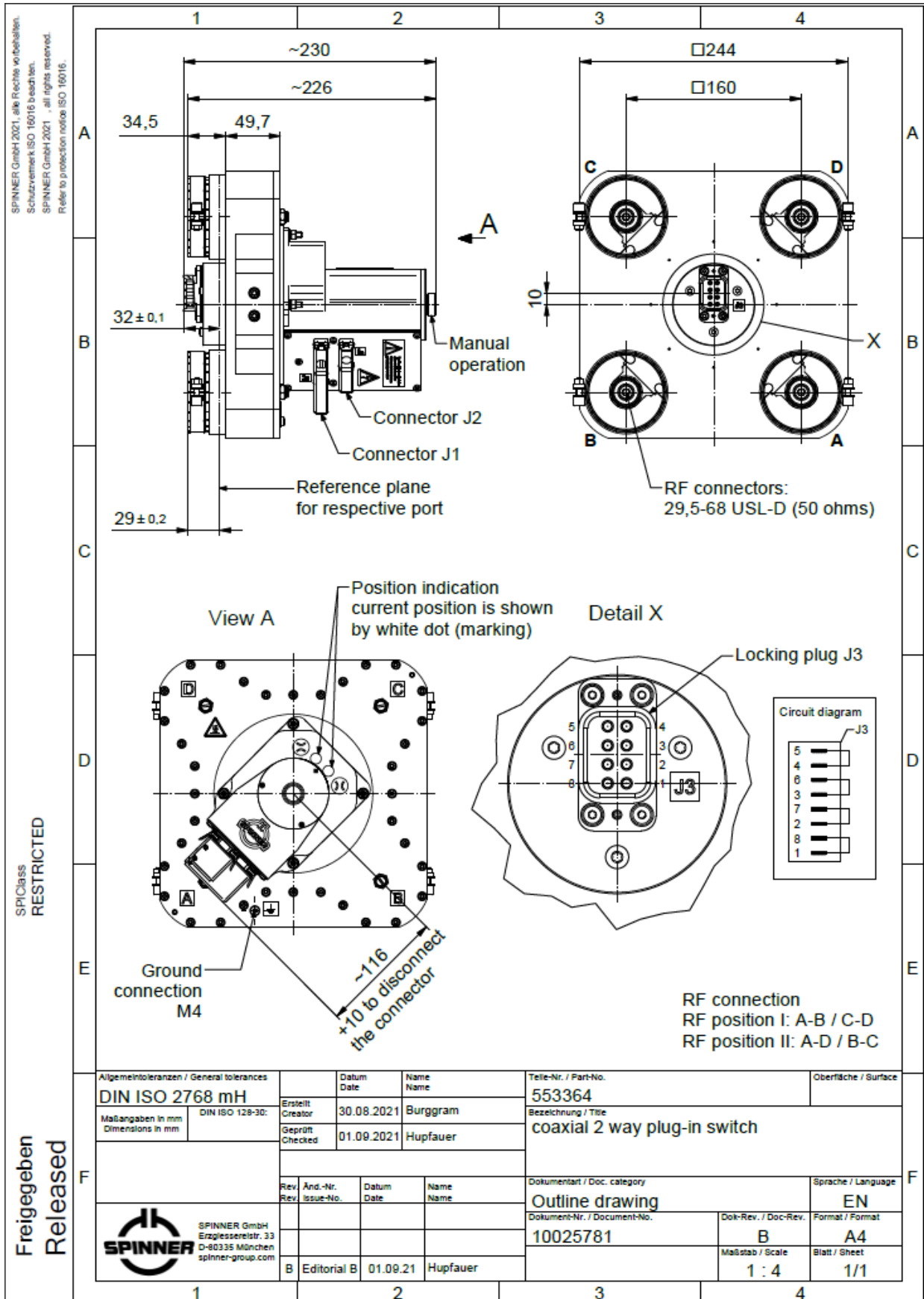

SPINNER GmbH
 This document is proprietary to us.
 All rights reserved. Any use, transfer, or reproduction of this document
 or the know-how contained therein requires our express consent.

Template 10014442.dwt

Coaxial Two Way Plug-in Switch (DPDT) | BN 553364

Circuit diagram

SPINNER GmbH
 This document is proprietary to us.
 All rights reserved. Any use, transfer, or reproduction of this document
 or the know-how contained therein requires our express consent.

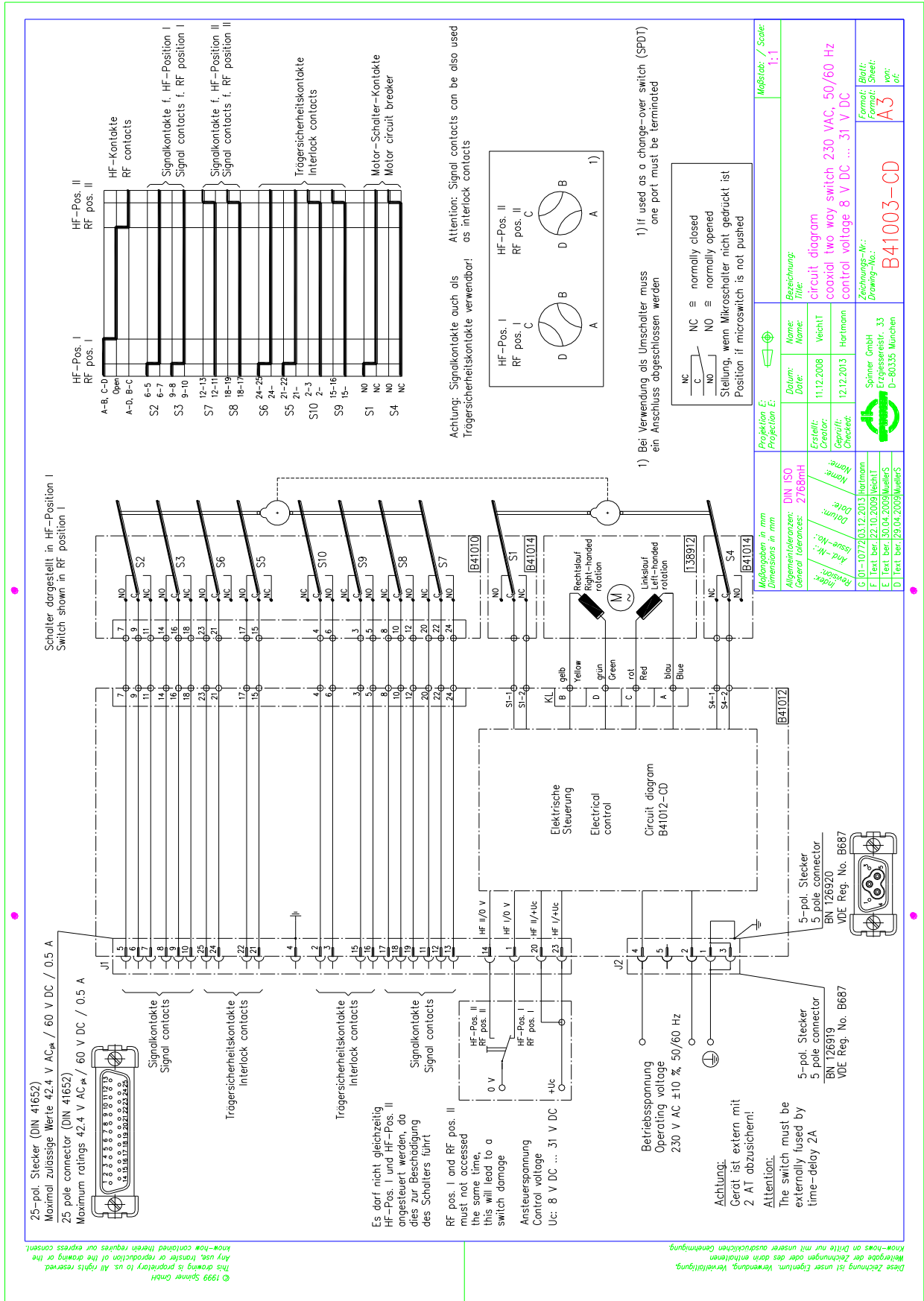

Diese Zeichnung ist unser Eigentum. Verwendung, Vervielfältigung, Weitergabe der Zeichnungen oder des darin enthaltenen Know-hows an Dritte nur mit unserer ausdrücklichen Genehmigung.
 This drawing is proprietary to us. All rights reserved. Any use, transfer or reproduction of the drawing or the know-how contained therein requires our express consent.

Coaxial Two Way Plug-in Switch (DPDT) | BN 553364

Cable socket

© 1999 Spinner GmbH, Elektrotechnische Fabrik
 This document is proprietary to us.
 Any use, transfer or reproduction of this document
 or the know-how contained therein requires our express consent.

Anleitung für den Kabelanschluss Instructions for cable connection

- Entfernen des Schutzgehäuses
Removing of the protective housing

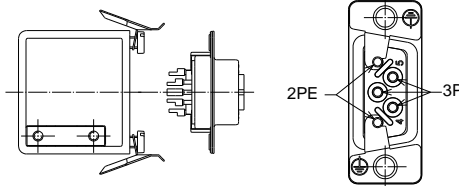

- Absetzen der Kabellitzen
Trimming of the cable strands



- Anbringen der drei Schrumpfschläuche (PIN 2/4/5)
3.a Placing of the three heat shrinks (pins 2/4/5)
- Löten der fünf Kabellitzen
3.b Soldering of the five cable strands

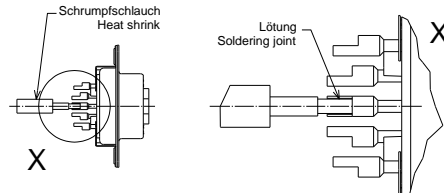

- Aufschumpfen der drei Schrumpfschläuche (PIN 2/4/5)
4.a Shrinking three heat shrinks (pins 2/4/5)
- Montage des Schutzgehäuses
4.b Assembling of the protective housing

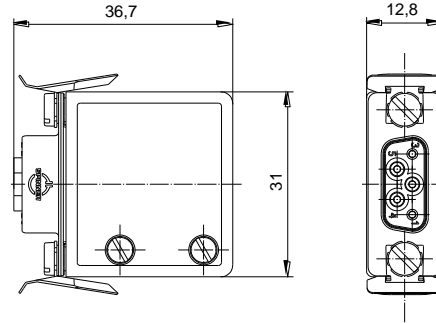
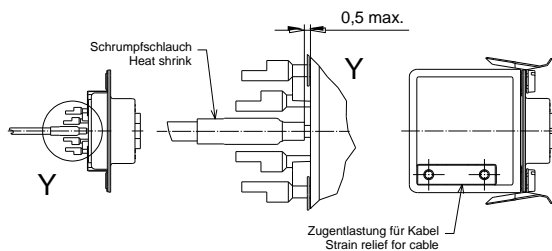

Technical data

5-polige Kabelkupplung 5 pole cable socket	ohne Schaltleistung Without breaking capacity
Bemessungsspannung Rated voltage	250 V AC
Bemessungsstrom Rated current	2 A
Bemessungsstoßspannung Rated impulse voltage	2.5 kV
Polzahl Number of poles	3P + 2PE
Anschlussart Kind of termination	Lötanschluss Solder termination
Leiterquerschnitt Cross section area	Max. 0.75 mm ² / min. 0.50 mm ²
Kabeldurchmesser Values for cable clamp	Ø 6 mm ... Ø 8 mm
Temperaturbereich Temperature range	-25 °C ... +85 °C
Steckzyklen Operation cycles	10
Schutzart Degree of protection	IP 20 nach / acc. to IEC EN 60529
Verschmutzungsgrad Degree of pollution	2
Max. Einsatzhöhe über N.N. Max. altitude above sea level	4000 m / 13,120 ft nach / acc. to IEC EN 60664-1
Schrumpfschlauch über Pins 2/4/5 Heat shrink above pins 2/4/5	
Zertifiziert nach Certified according to	VDE-Reg.-No. B687 DIN EN 61984: 2009-11; EN 61984: 2009
Zugelassene Steckerleiste Approved plug connector	BN 126920

**Beim Anschluss eines Kabels sind die gültigen Sicherheitsvorschriften zu beachten!
Please attend the valid safety rules for assembling!**

Konstruktionsänderungen vorbehalten
Design is subject to change without notice

Maßangaben in mm Dimensions in mm		Projektion E: Projection E:		Maßstab: / Scale: —	
Allgemeintoleranzen: General tolerances: DIN ISO 2768mH		Datum: Date: 31.01.2011	Name: Name: Frank	Bezeichnung: Title: Kabelkupplung cable socket	
Index: Revision:	Äng.-Nr.: Issue-No.:	Erstellt: Creator: 31.01.2011	Frank	5-polig / 5 pole, 250 VAC	
Datum: Date: 01-0907127.02.2013	Name: Name: Hupfauer	Geprüft: Checked: 12.12.2013	Hartmann	Zeichnungs-Nr.: Drawing-No.: 126919-0E	
D 01-1077203.12.2013	Hartmann	Spinner GmbH Erzgiesserei-Str. 33 D-80335 München		Format: Format: A4	Blatt: Sheet: 1
C 01-0907127.02.2013	Hupfauer			von: of: 1	
B DIV.CORR01.02.2011	Frank				
A Startindex	31.01.2011	Frank			

Diese Zeichnung ist unser Eigentum. Verwendung, Vervielfältigung,
 Weitergabe der Zeichnungen oder des darin enthaltenen
 Know-hows an Dritte nur mit unserer ausdrücklichen Genehmigung.

SPINNER GmbH
 This document is proprietary to us.
 All rights reserved. Any use, transfer, or reproduction of this document
 or the know-how contained therein requires our express consent.