

COAXIAL LOAD

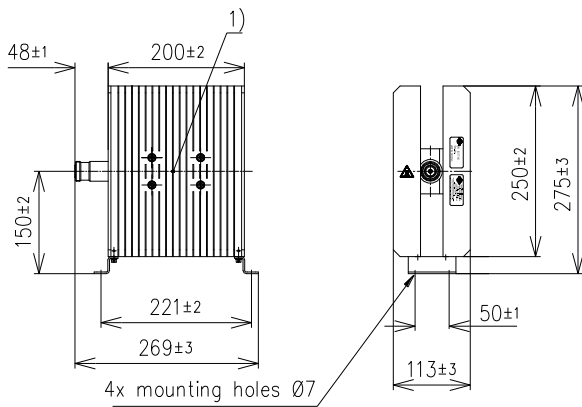

Part number	BN 53 77 40	
Connector type	7-16 socket	
Power rating	400 Watt max. 2)	
Impedance	50 Ω	
Frequency range	0 - 860 MHz	
VSWR	≤ 1.06	
Material and surface		
Inner conductor	copper alloy	silver-plated
Outer conductor	copper alloy	silver-plated
Housing	aluminium alloy	
Other metal parts	aluminium alloy stainless steel	
Insulation	PTFE	
Heat sink	aluminium alloy	anodised (black)
Degree of protection	IP40	
Standards	IEC 61169-4	
Ambient temperature	-40 °C - +40 °C full power 2)	
Weight	approx. 5 kg	
Operating position	Cooling fins vertically	

1) Measuring point for surface temperature, see graph

2) The maximum power handling is reduced with rising ambient temperatures as follows

COAXIAL LOAD

