

COAXIAL LOAD

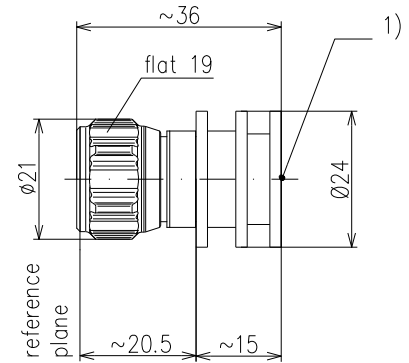

Part number	BN 53 17 27			
Connector type	N plug			
Power rating	5 Watt max. 2)			
Impedance	50 Ω			
Frequency range	0 - 1 GHz	1 - 2 GHz	2 - 5 GHz	5 - 7 GHz
VSWR	≤ 1.06	≤ 1.11	≤ 1.17	≤ 1.22
Material and surface				
Inner conductor	CuBe age hardened		silver-plated	
Outer conductor	copper alloy		silver-plated	
Other metal parts	copper alloy aluminium alloy		bright nickel-plated black lacquered	
Insulation	PTFE			
Sealing	silicone			
Degree of protection	IP 64			
Standards	IEC 61169-16			
Weight	approx. 0.04 kg			
Operation position	any			

1) Measuring point for surface temperature, see graph

2) The maximum power handling is reduced with rising ambient temperatures as follows

