

CONTACT SHIM

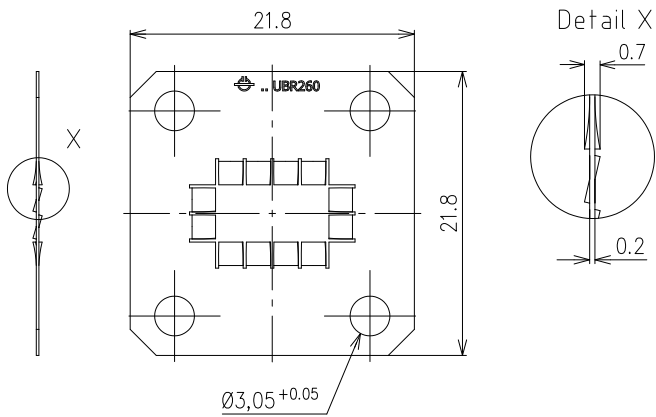

Part number	BN 00 38 34	
Configuration		
Waveguide	R260 (WR34)	
Flange	similar UBR	
Material and surface	CuBe	untreated
Standards	IEC 60154-2	
Weight	approx. 0.001 kg	