

Rigid Line Components 1 5/8" EIA

- Very stable rigid line system
- Low insertion loss
- Low VSWR
- PTFE insulation
- Designed for pressure tight systems
- For outdoor application

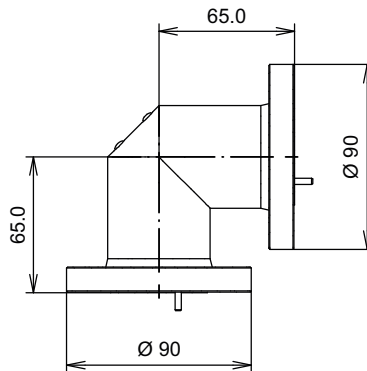

90° Elbow
BN 938520

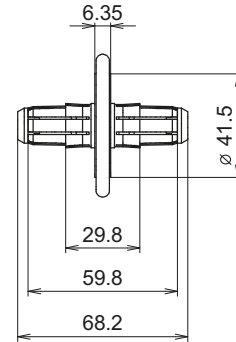

Coupling element
BN 918311

Components

	Length	Weight	Part Number
Inner conductor tube (copper)	L = 2 m L = 4 m	0.89 kg 1.78 kg	BN A02406 BN K19640C0004
Outer conductor tube (copper)	L = 2 m L = 4 m	2.78 kg 5.56 kg	BN A02407 BN K19608C0004
Rigid line (inner + outer conductor) with fixed flanges, custom-designed length Please define length in mm with your order. Spinner generates a part number extension for every specific length (V****).	0.09 m ≤ L ≤ 1.4 m 1.4 m < L ≤ 2.8 m 2.8 m < L ≤ 4 m		BN 859900V**** BN 859991V**** BN 859992V****
Inner support		≈ 0.04 kg	BN 859906
Fixed flange for brazing		≈ 0.42 kg	BN 006111
Coupling element incl. screw set		≈ 0.16 kg	BN 918311
90° Elbow		≈ 1.36 kg	BN 938520

Electrical Data

Impedance		50 Ω
Cut off frequency for H11-Mode		3.2 GHz
Proof voltage at sea level (NN)		7.0 kV
Frequency range		0 ≤ f ≤ 2.7 GHz
Average power at +40 °C ambient temperature	100 MHz 230 MHz 860 MHz	≤ 20.0 kW ≤ 13.5 kW ≤ 7.0 kW
Attenuation at +20 °C ambient temperature (dB/100m)	100 MHz 230 MHz 860 MHz	0.63 0.95 1.83

Rigid Line Components 1 5/8" EIA

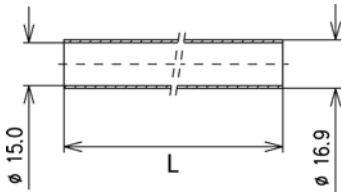

Inner conductor tube
BN A02406; BN K19640

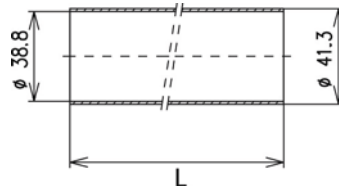

Outer conductor tube (not painted)
BN A02407; BN K19608

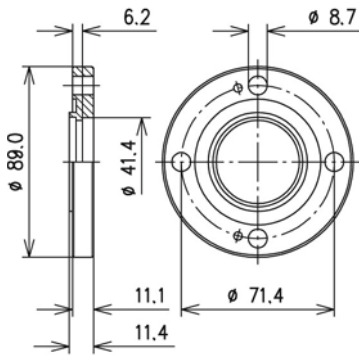

Fixed flange for brazing
BN 006111

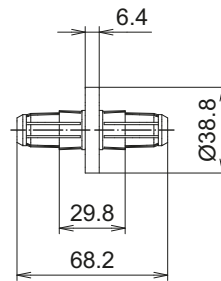

Inner support
BN 859906

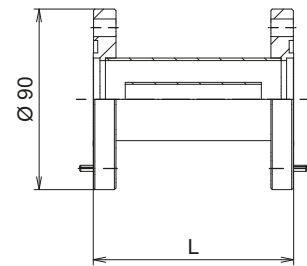

Rigid line
BN 859900V****

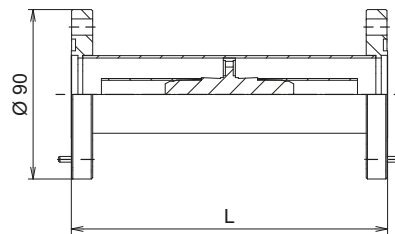

Rigid line
BN 85991V****

Length of rigid line L	Number inner supports required
$1.4 \text{ m} \leq L \leq 2.8 \text{ m}$	1
$2.8 \text{ m} < L \leq 4.0 \text{ m}$	2

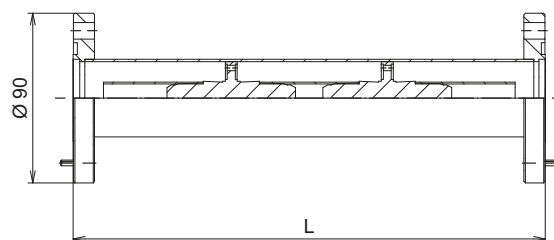

Rigid line
BN 85992V****