

MIMO X-Pol Panel Antenna, 698MHz-2700MHz

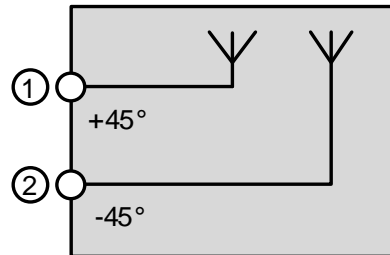

not binding



block diagram

Part number		BN A77136C0001					
Connector		2 x 4.3-10 female (50 Ω)					
Frequency range, [MHz]		698-806	806-960	1710-1880	1920-2170	2200-2500	2490-2700
Gain, [dBi]		6.4	7.5	8.1	8.1	8.1	7.1
Polarization, [deg]		+45 / -45					
Beam width, [deg]	Horizontal	61-82			63-87		
	Vertical	55-80			55-85		
Front-To-Back Ratio, [dB]		≥ 10			≥ 15		
VSWR		≤ 1.5					
Isolation, [dB]		> 20			> 23		
Intermodulation (IM3) @ 2x 20 W, [dBc]		≤ -150					
Input power, [W]		max. 50					
Degree of protection		Indoor / IP54					
Weight, without Mounting Kit, [kg]		0.88					
Radome Material and Color		ABS, White, RAL9003					
Temperature range, [°C]		-55 – +60					
Dimensions (H x W x D), [mm]		308 x 190 x 82					
Operational Humidity		< 95%					
RoHS		Compliant					
Flammability rating		UL 94-V0					
Mounting Kit		On-wall					

**Radiation pattern:**

**Horizontal  
pattern**

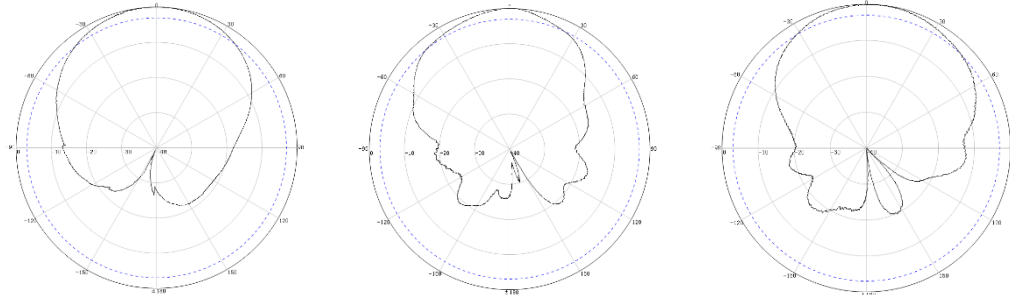

**Vertical  
pattern**

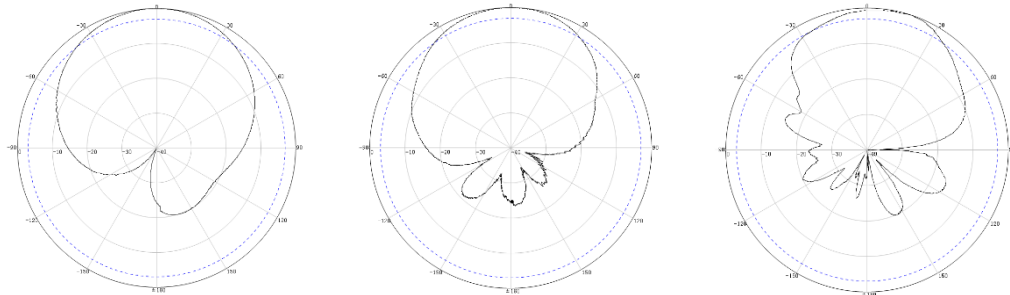

900MHz

1710MHz

2500MHz

**Dimensions and mounting:**

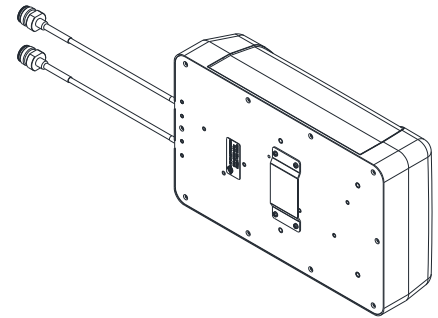
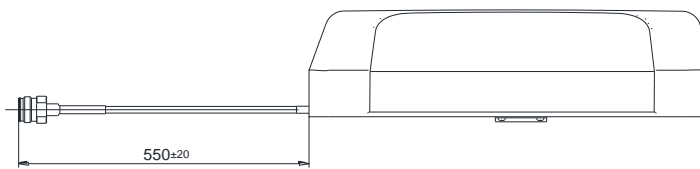
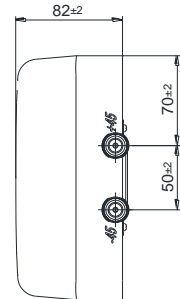
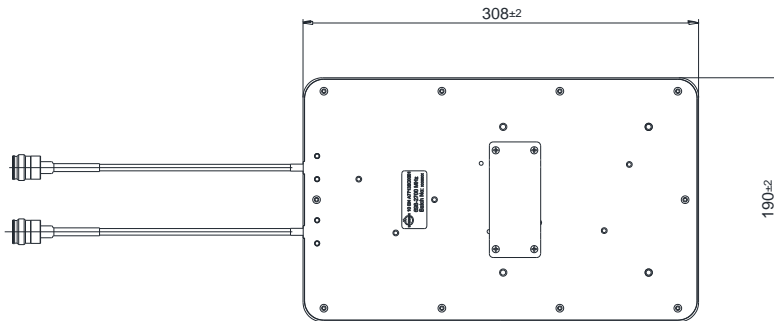

**Standard:**

4.3-10 female (50 ohms): IEC 61169-54;

Subject to change without notice

**Mounting kit:**

