

Coaxial DC-Block

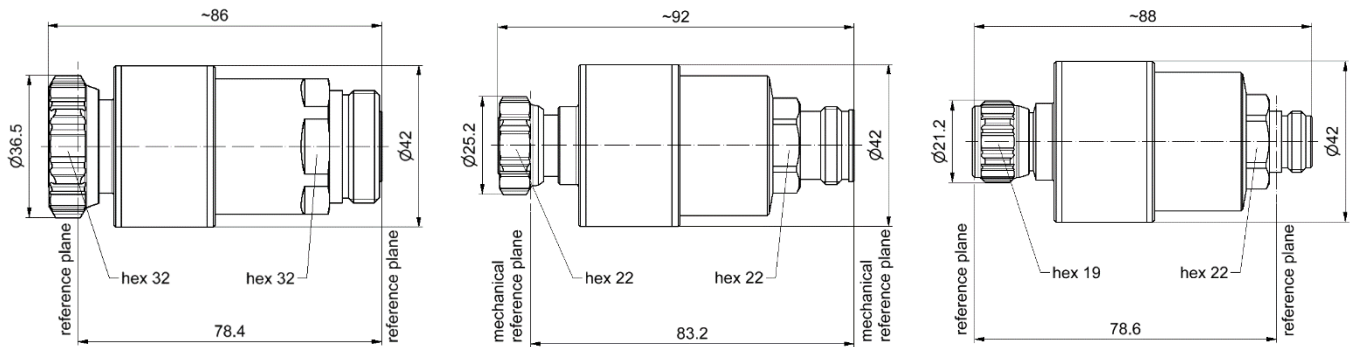

BN 766436F001

BN 432054F001

BN 950720F001

all dimensions in millimeter

Radio frequency characteristics

Part number	BN 766436F001	BN 432054F001	BN 950720F001
Interface type	7-16 plug / socket (50 Ω) per IEC 61169 4	4.3-10 plug / socket (50 Ω) per IEC 61169 54	N plug / socket (50 Ω) per IEC 61169 16
Intermodulation (IM3) 2x20 W, max.	-160 dBc (typ. -165 dBc)	-160 dBc (typ. -165 dBc)	-155 dBc (typ. -160 dBc)
Configuration	Inner and outer conductor separated		
Frequency range	33 to 4000 MHz 5150 to 6000 MHz		
Insertion loss, max.	0.60 dB (typ. 0.45 dB) @ 33 to 80 MHz 0.25 dB (typ. 0.10 dB) @ 80 to 3800 MHz 0.60 dB (typ. 0.45 dB) @ 3800 to 4000 MHz 0.60 dB (typ. 0.45 dB) @ 5150 to 6000 MHz		
VSWR, max.	2.10 (typ. 1.80) @ 33 to 80 MHz 1.40 (typ. 1.28) @ 80 to 100 MHz 1.30 (typ. 1.22) @ 100 to 300 MHz 1.10 (typ. 1.06) @ 300 to 1880 MHz 1.20 (typ. 1.11) @ 1880 to 2700 MHz 1.25 (typ. 1.19) @ 2700 to 3800 MHz 1.35 (typ. 1.33) @ 3800 to 4000 MHz 1.40 (typ. 1.38) @ 5150 to 6000 MHz		
RF CW power, max. (for VSWR=1,0 at sea level, ambient temperature 40°C)	2000 W @ 33 MHz 1500 W @ 80 MHz 300 W @ 1880 MHz 250 W @ 2700 MHz 130 W @ 3800 MHz 120 W @ 4000 MHz 80 W @ 6000 MHz		
Blocking DC voltage (for VSWR=1,0 at sea level, ambient temperature 20°C)	3000 V (outer to outer conductor) 3000 V (inner to inner conductor)		

SPINNER GmbH
 This document is proprietary to us.
 All rights reserved. Any use, transfer, or reproduction of this document
 or the know-how contained therein requires our express consent.

Coaxial DC-Block

Mechanical characteristics

Inner conductor material / surface finish	copper alloy / silver-plated
Outer conductor material / surface finish	copper alloy / silver-plated
Other metal parts / surface finish	copper alloy / bright nickel-plated
Insulation	PTFE, POM, Polyimide
IP protection	IP67 per EN 60529 (interface connected with appropriate gasket)
Sealing	silicone rubber
Temperature range	-40°C to +55°C
Weight, approx.	0.3 kg