

CABLE PLUG FOR LF 1/4"-50-TYPE 7-16

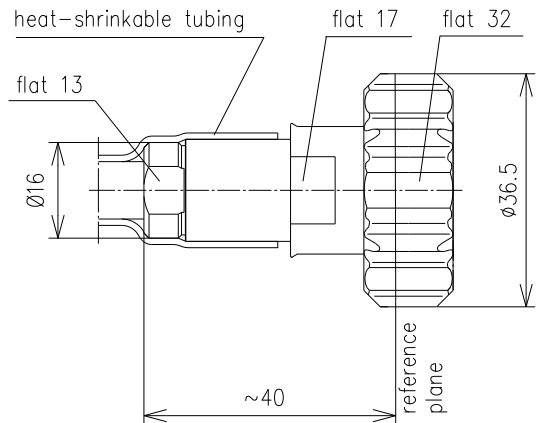

Part number	BN 74 14 45		
Connector type	7-16 plug		
Version	CAF®		
Impedance	50 Ω		
Frequency range	0 - 1 GHz	1 - 2.7 GHz	2.7 - 3.8 GHz
VSWR	≤ 1.02	≤ 1.04	≤ 1.06
Material and surface			
Inner conductor	copper alloy	silver-plated	
Outer conductor	copper alloy	silver-plated	
Other metal parts	copper alloy	bright nickel-plated	
Insulation	PTFE		
Sealing	silicone rubber, heat-shrinkable adhesive tubing		
Degree of protection	IP68 (mated)		
Cable compatibility	RFS	LCF 14-50	
Standards	IEC 61169-4		
Installation instructions	M30719		
Weight	approx. 0.09 kg		
Included in delivery	sealing, installation instructions		