

Precision Inter-series Adaptor || BN 533126

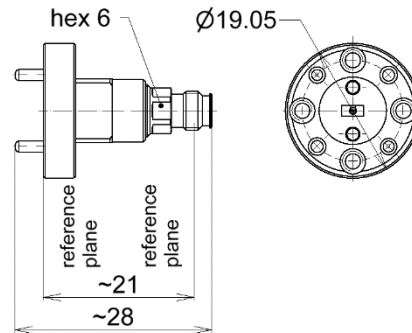

all dimensions in millimeter

**Radio frequency characteristics**

Interface type	R 740 compatible to IEC 60153-2 (WR 12 per EIA RS-261) / 1.35 mm socket per IEEE Std 287
Waveguide interface connector	precision flange with anti-cocking rim compatible to IEC 60154-2 compatible to M3922/67-009 (UG-387/U)
Frequency range	60 to 90 GHz
Impedance	50 Ω
Return loss, min.	16 dB min. (20 dB typ.) @ 60 to 90 GHz

**Mechanical characteristics**

Center conductor material / surface finish	CuBe age hardened / gold-plated
Outer conductor material / surface finish	CuBe / gold-plated copper alloy / gold-plated
Insulation	PS
Other metallic parts / surface finish	stainless steel
Weight, approx.	0.02 kg
Marking	laser engraving

**Environmental conditions**

<b>Operation</b>	
Ambient temperature range	+18 to +28°C
<b>Storage</b>	
Ambient temperature range	-40 to +70°C
Relative humidity	95% (non condensing)

**Scope of delivery and accessories**

Scope of delivery	protective caps
-------------------	-----------------

SPINNER GmbH  
 This document is proprietary to us. All rights reserved. Any use, transfer, or reproduction of this document or the know-how contained therein requires our express consent.