

Coaxial 4+1-Switching Unit - BN 512665 Coaxial 2+1-Switching Unit - BN 512663

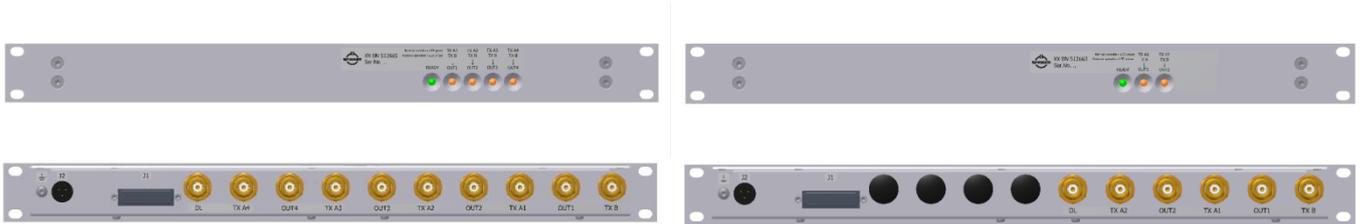

1 Technical Data

RF Data		
Frequency Range	0 < f ≤ 864 MHz	864 < f ≤ 1500 MHz
Isolation	min. 45 dB	min. 40 dB
Insertion Loss	max. 0.25 dB shortest path BN 512665: max. 0.6 dB longest path BN 512663: max. 0.4 dB longest path	max. 0.35 dB shortest path BN 512665: max. 0.7 dB longest path BN 512663: max. 0.5 dB longest path
Return Loss	min. 30 dB shortest path BN 512665: min. 25 dB longest path BN 512663: min. 27 dB longest path	min. 22 dB shortest path BN 512665: min. 20 dB longest path BN 512663: min. 22 dB longest path
Average Power Rating per Input**	max. 130 W	max. 95 W
Proof Voltage**	max. 1000 V	
Characteristic Impedance	50 Ohms	
Power Supply		
Supply Voltage	10.8 V DC to 26.4 V DC, input is potential-free, SELV (according to EN-60950-1)	
Power Consumption	20 W maximum while switching	
Connector, J2*	3 pole snap-in connector Binder series 720	
Nominal Fuse	The power supply lines must be externally fused by time-delay, 2 A	
Environmental Conditions		
Temperature Range	Operation: -10 °C to +50 °C Storage: -25 °C to +70 °C	
Humidity	Operation / Storage: max. 95 % RH (condensation not allowed)	
Operational Environment**	Indoor use only, maximum altitude 2286 m / 7500 ft above sea level for operation at indicated power	
Installation Position	any	
Protection Class	III (according to EN-60950-1)	
Degree of Protection	IP 30 (according to EN-60529 / VDE 0470-1)	

* Suitable mating connector included

** Standard conditions:

Dielectric: Dry air under standard pressure
 Temperature of the environment: T_{env} = 40 °C
 At maximum altitude 2286 m / 7,500 ft above sea level, derating of input power at increasing altitude above 2286 m / 7,500 ft sea level:
 -1 % / 75 m respectively -1 % / 250 ft (referring to CECC 22000)

Coaxial 4+1-Switching Unit - BN 512665 Coaxial 2+1-Switching Unit - BN 512663

Interface	
Connector, J1	Sub-D, 25 pole, male (according to DIN 41652 / IEC 807-2)
Control Input	BN 512665: 8 input lines (2 per switch), potential-free, either polarity in respect to "COMIN" BN 512663: 4 input lines (2 per switch), potential-free, either polarity in respect to "COMIN"
Input Voltage @ Control Input	8 V DC to 28 V DC, SELV (according to EN-60950-1)
Input Current @ Control Input	5 mA maximum (1 mA to 5 mA, depending on input voltage)
Command Hold Time	min. 100 ms (while this time, the voltage at Control Input must not change)
Monitoring Output	BN 512665: 10 output lines (2 per TX A, 1 to TX B, 1 Ready), potentially free contacts, all contacts in respect to "COMOUT" BN 512663: 6 output lines (2 per TX A, 1 to TX B, 1 Ready), potentially free contacts, all contacts in respect to "COMOUT"
Contact Rating of Monitoring Output	50 V DC maximum voltage, 100 mA maximum current, 6 Ohms typically 15 Ohms maximum contact resistance
Signalling	BN 512665: 4 bicolor LED's, green: TX An to OUTn, amber: TX B to OUTn BN 512663: 2 bicolor LED's, green: TX An to OUTn, amber: TX B to OUTn both: 1 green LED: Ready, no failure
Current Limiting to Interface	All interface lines must be externally limited to 100 mA
Mechanical Data	
RF Interface	N female (according to IEC 61169-16, CECC 22210)
Switching Time	max. 100 ms
Switching Characteristic	bistable (latching)
Design Configuration	1 RU plug-in module for a 19" rack or a compact box
Lifetime	min. 100,000 cycles
Weight	BN 512665: 5 kg BN 512663: 3.5 kg

Coaxial 4+1-Switching Unit - BN 512665 Coaxial 2+1-Switching Unit - BN 512663

2 Technical Description

2.1 Control and Monitoring Interface

For controlling the Coaxial Switching Unit a parallel control input is provided. The actual position of each RF-switch as well as the correct connection of TX B and a "Ready" message is available at the parallel monitoring output. All input lines and output lines are accessible at one Sub-D connector.

2.2 Control Input

The potentially free input accepts voltages of 8 V DC to 28 V DC of either polarity. The input resistance is about 7.5 kOhms. For each RF-switch two input lines are provided. The voltages to the input lines are in respect to "COMIN". For example input line IN 1.1 activates routing of TX A1 to OUT1. The input line IN 1.2 activates routing of TX B to OUT1 and TX A1 to DL (Dummy Load). The other input lines work in the same way.

The newest received and valid command is internally stored non volatile. After the command is operated, the control input lines can be disabled. Due to the non volatile storage of the commands, the position stays stable even after power on.

2.3 Monitoring

The potentially free monitoring contacts accept external voltages of up to 50 V DC of either polarity. The current through the contacts must be externally limited to a value smaller than 100 mA. The contact resistance is typically 6 Ohms and 15 Ohms in the maximum. One pole of each contact is internally connected to "COMOUT".

For each RF-switch two monitoring contacts, showing the position of the switch, are provided. The monitoring signals follow logically the input signals, as long as the commands are executed successfully. In the detail this means that IN 1.1 is related to O 1.1, IN 1.2 is related to O 1.2 and so on. As long as the RF-switch is in a stable position, the corresponding monitoring contact is closed. If a command to change the current switching position is received, the concerned monitoring contact will open immediately to acknowledge this request. The actuator will then be triggered 20 ms after the monitoring contact was opened. After the new switching position is set, the monitoring contact will be closed 20 ms later. The switching position is constantly compared to the last stored command by reading the current position of the actuator. Any uncertainty will cause opening the related monitoring contact.

The monitoring contact O 5.1 is logically linked to TX B. This contact is closed if the RF signal path is confirmed.

If an internal error is detected, e.g. a failure of the actuator voltage, then the "Ready" contact O 5.2 will open immediately. Maintenance has to be done in this case since the next switching request might be faulty.

2.4 Signalling

LED's at the front panel show the actual status of the Coaxial Switching Unit. Four (BN 512665) / two (BN 512663) bicolor LED's signalize the RF-switch position. They light up green when the RF-switch connects TX An to OUTn and amber when TX B is connected to this port instead.

In normal operation the "READY" LED lights up green, in case of an error the LED goes off.

2.5 Power Supply

The unit works well at a supply voltage from 10.8 V DC to 26.4 V DC. The power consumption is below 20 W while switching, otherwise below 3 W. The power supply is potential free against case ground and against the interface signals.

Power supply can be connected by either a 3-pole round connector or the Sub-D interface connector. The current must be externally limited to 2 A by means of a fuse.

A M4 ground connection is provided for grounding case and shield of the interface connector.

3 Typical Diagrams (BN 512665)

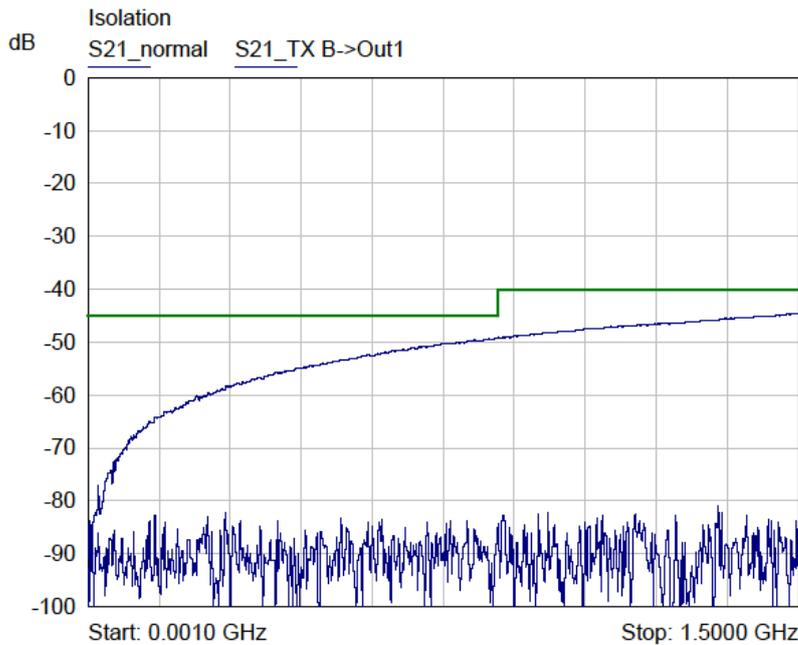
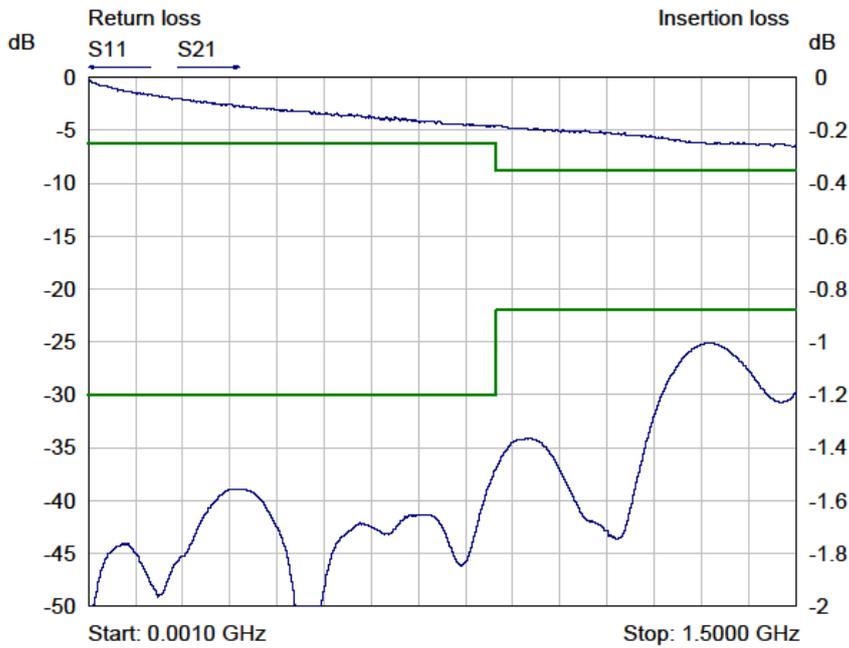

Coaxial 4+1-Switching Unit - BN 512665 Coaxial 2+1-Switching Unit - BN 512663

4 Dimensions Coaxial 4+1-Switching Unit BN 512665

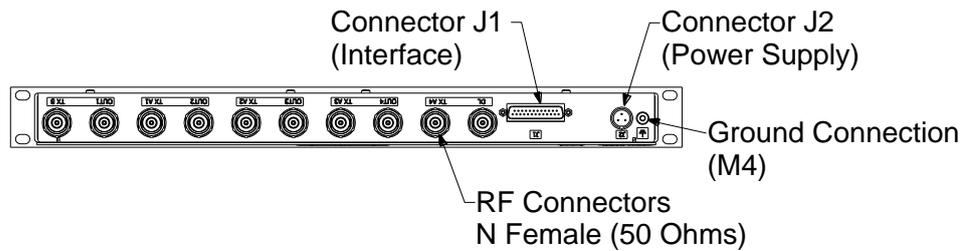
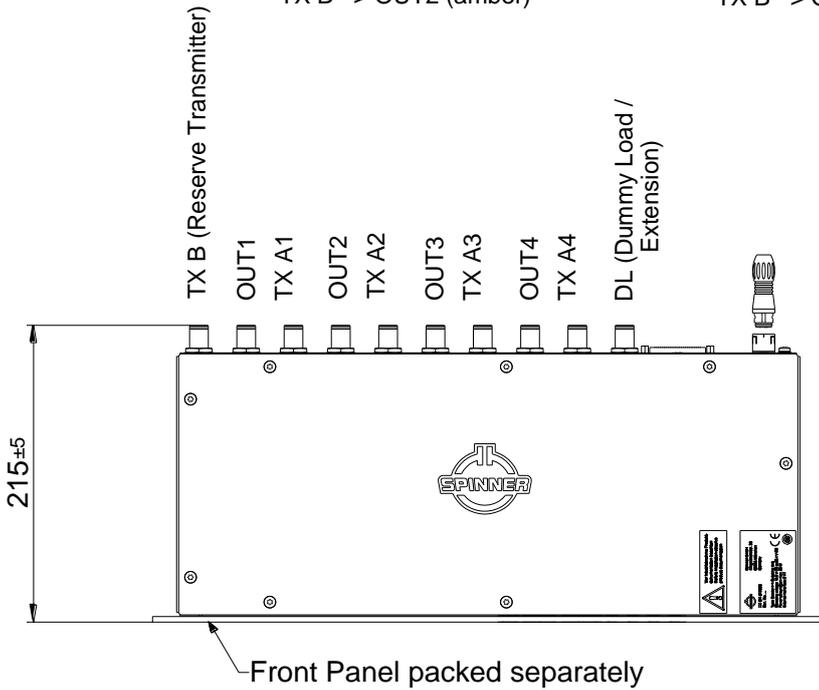
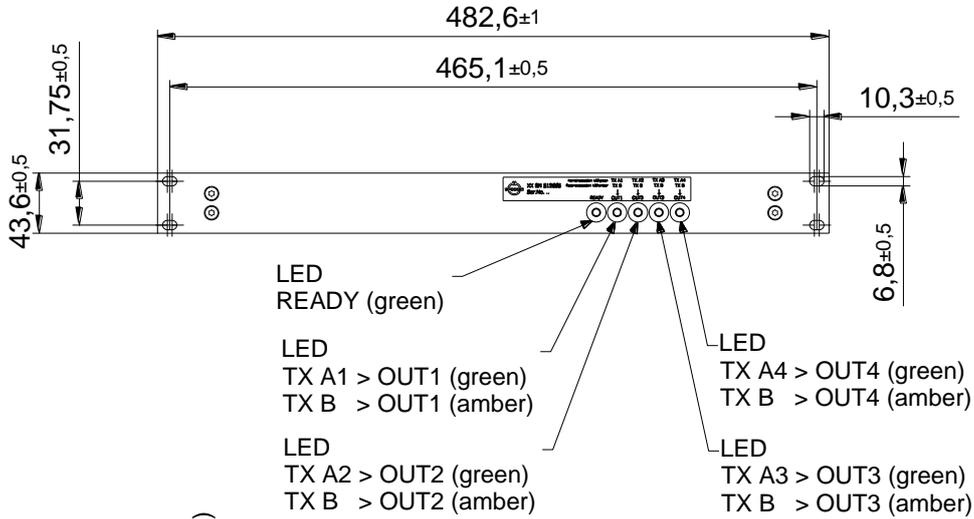

Coaxial 4+1-Switching Unit - BN 512665 Coaxial 2+1-Switching Unit - BN 512663

5 Dimensions Coaxial 2+1-Switching Unit BN 512663

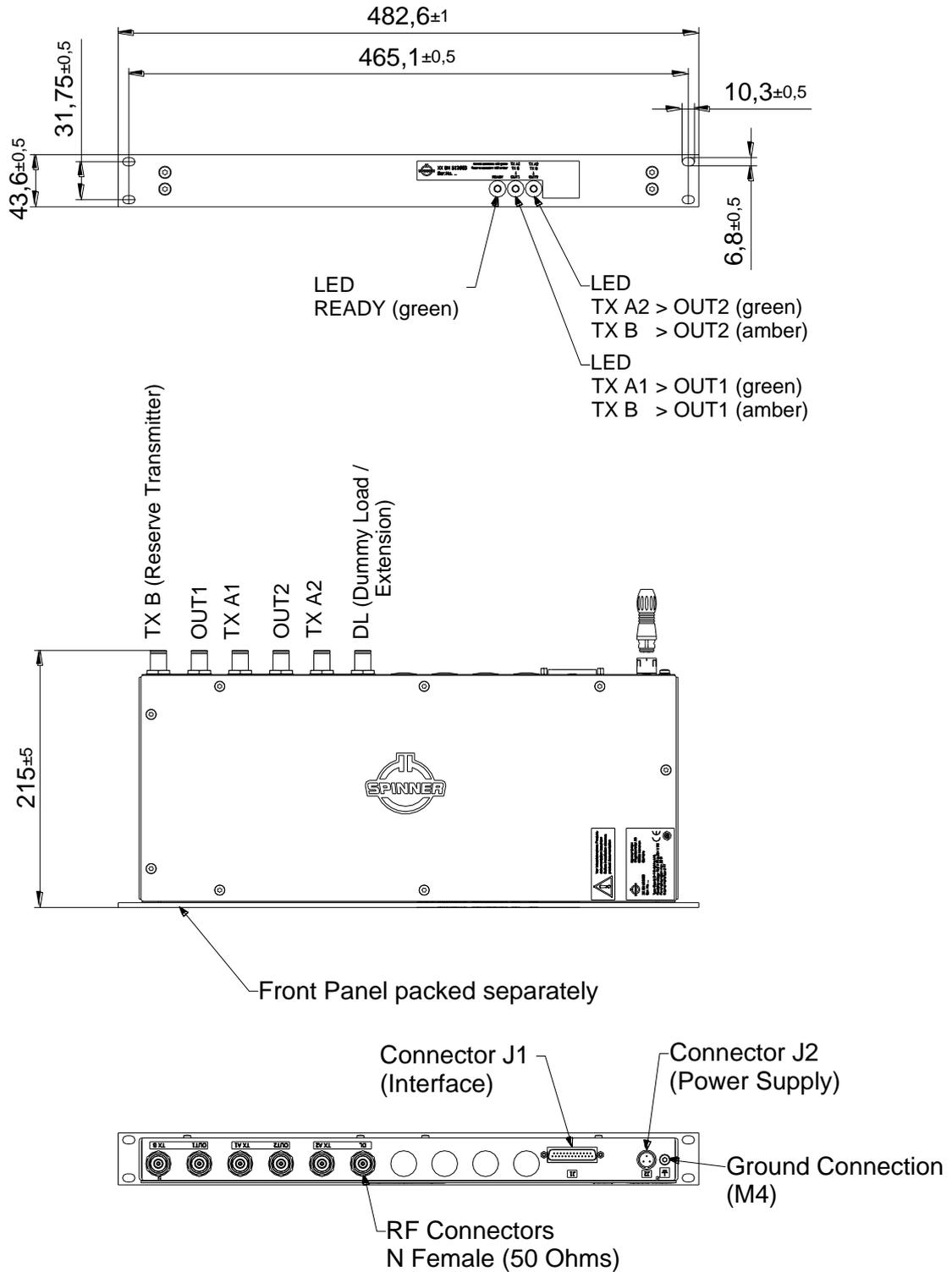

Coaxial 4+1-Switching Unit - BN 512665 Coaxial 2+1-Switching Unit - BN 512663

6 Block Diagram Coaxial 4+1-Switching Unit BN 512665
Switch position shown in normal operation

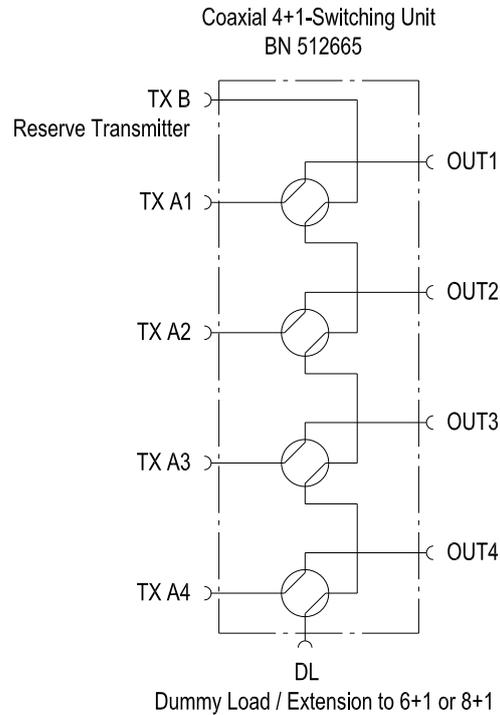

7 Block Diagram Coaxial 2+1-Switching Unit BN 512663
Switch position shown in normal operation

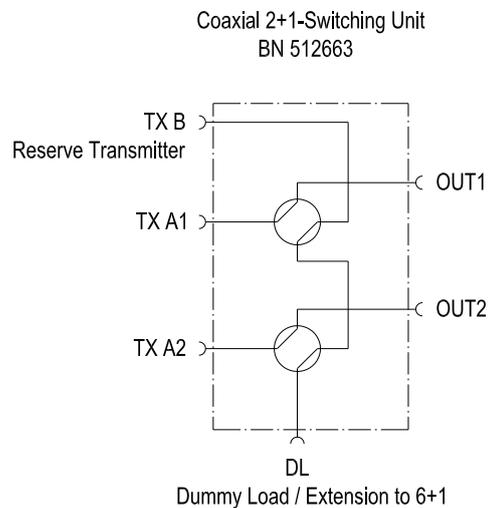

Coaxial 4+1-Switching Unit - BN 512665 Coaxial 2+1-Switching Unit - BN 512663

8 Circuit Diagram Coaxial 4+1-Switching Unit BN 512665

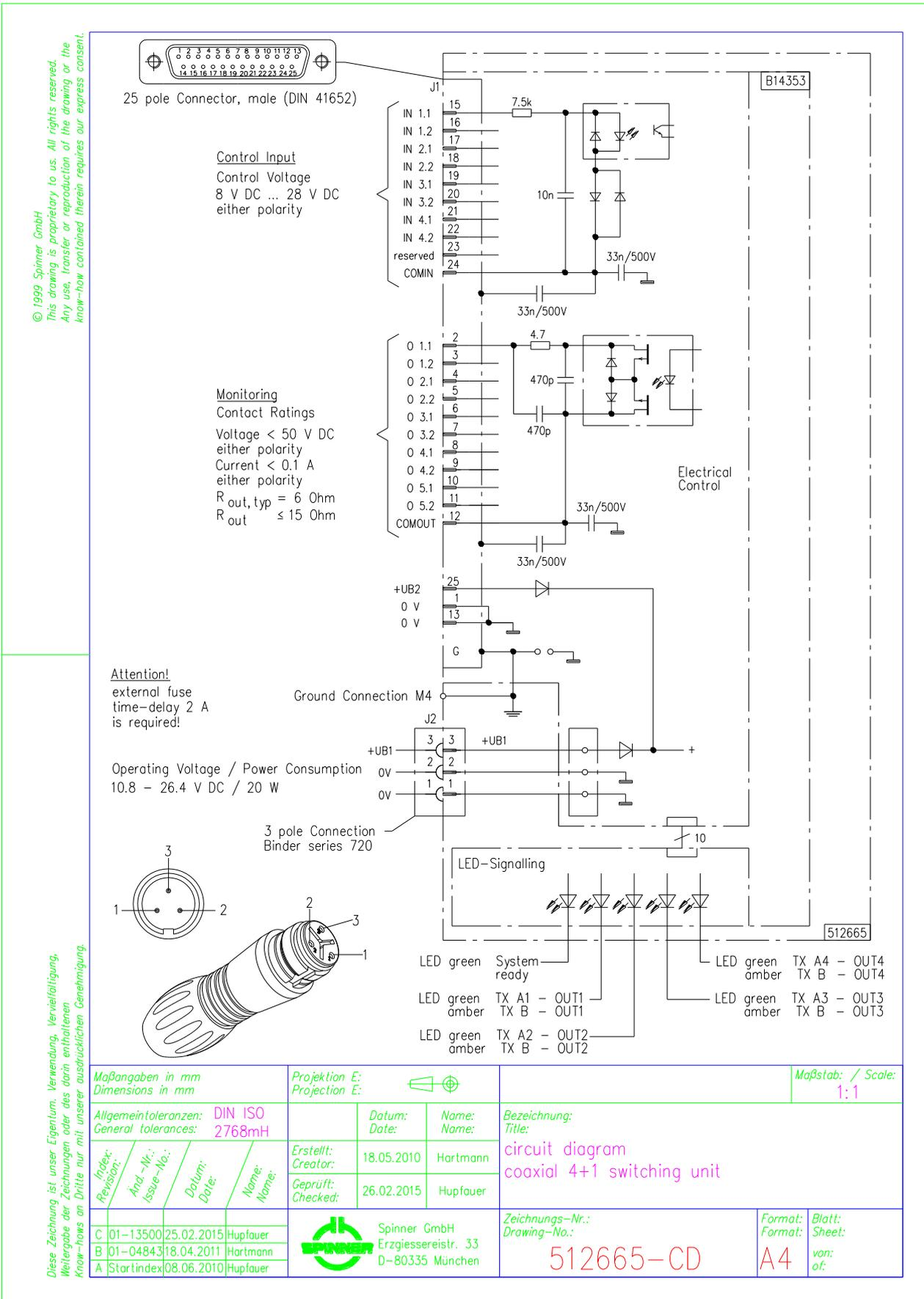

Coaxial 4+1-Switching Unit - BN 512665 Coaxial 2+1-Switching Unit - BN 512663

9 Circuit Diagram Coaxial 2+1-Switching Unit BN 512663

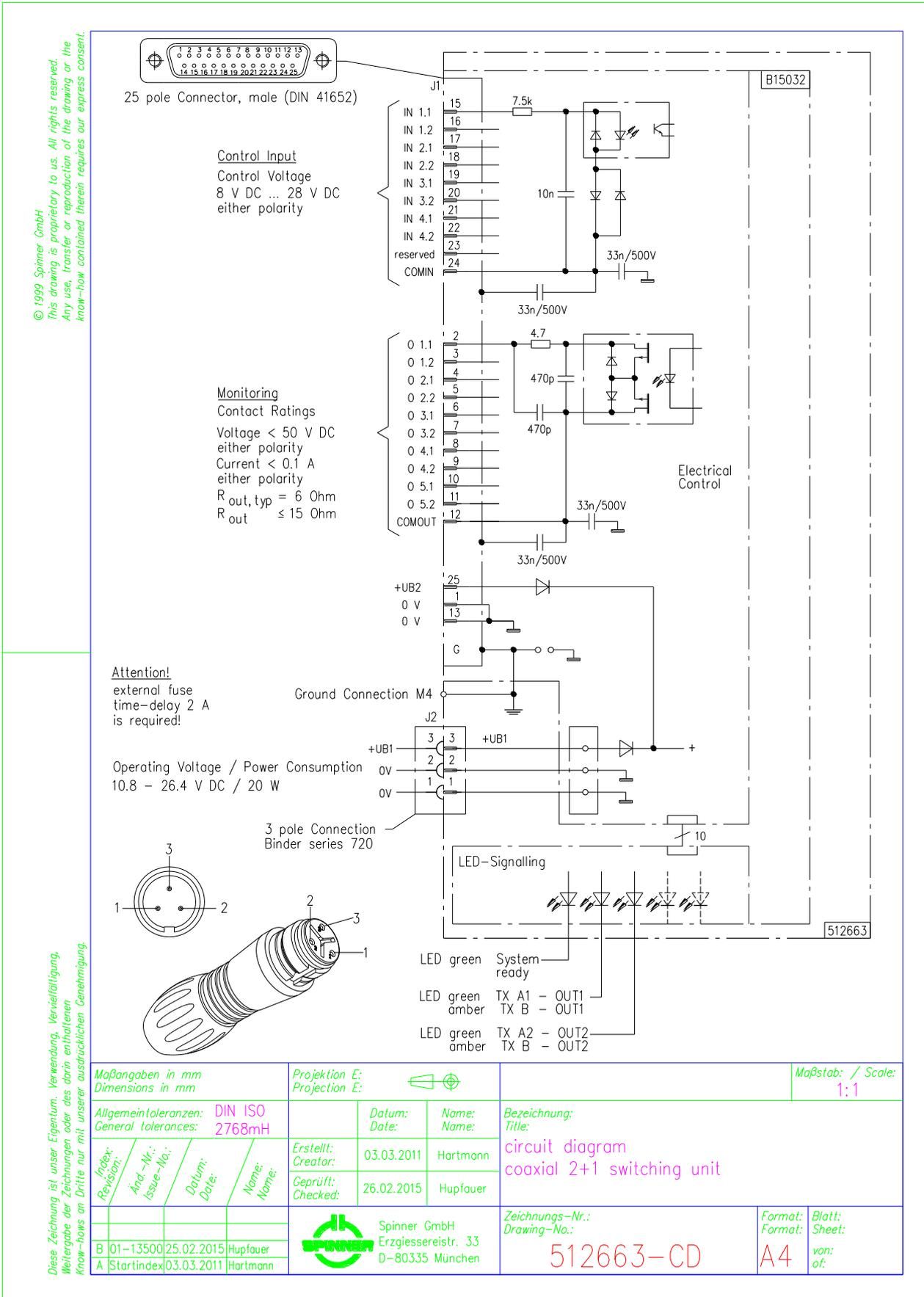

Coaxial 4+1-Switching Unit - BN 512665 Coaxial 2+1-Switching Unit - BN 512663

10 Cascading

To extend Coaxial Switching Units to achieve a 6+1-Switching Unit or a 8+1-Switching Unit the “DL port” of the first Unit has to be connected to the “TX B port” of the second Unit. The Dummy Load will be then connected to the “DL port” of the second Unit. The reserve transmitter remains connected to the “TX B port” of the first Unit.

In addition to the interface of the first Unit a second interface has to be provided for the extension Unit.

Therefore two interfaces and two operating voltage cables are necessary. The control system has to activate 8 (12) control lines and to read 10 (16) monitoring signals.

While there is no logical interconnection between both Units, the control system itself must generate the "Ready" signal and the "TX B" signal by a Boolean operation to get the final result.

When cascading two Units, the TX B insertion loss for the longest path will double and the return loss will decrease max. 6 dB.

Cascaded Coaxial 8+1-Switching Unit

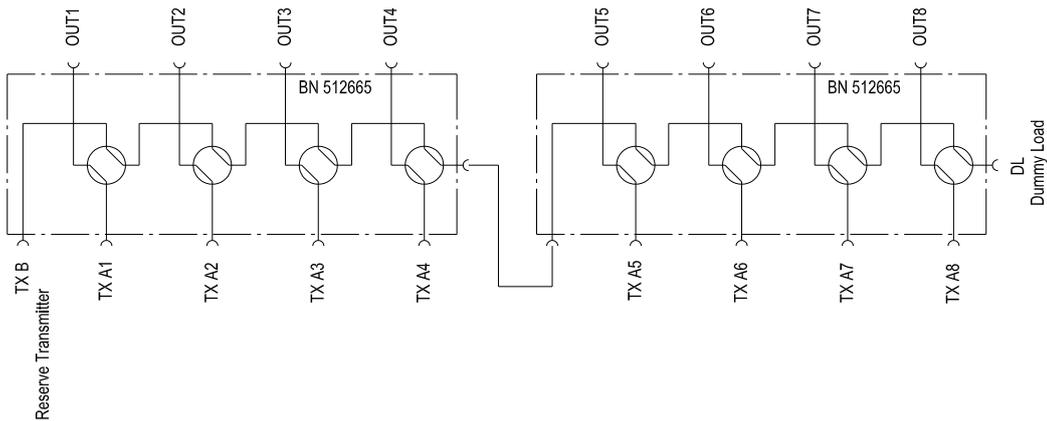

Cascaded Coaxial 6+1-Switching Unit

